

Spot Submission Quick Reference Guide



Spot Submission Quick Reference Guide

Free Delivery Method

*Other Acceptable Methods *Fees Incurred*



Centaur



Centaur Get Started Guide

Centaur delivers to a vast network of media destinations, with the best price, speed, and reliability in the industry. Our platform enables simple online ordering, fast volume uploads, tracking and delivery confirmation, storage, and team collaboration. See below to get started.

Sign Up:

Sign up at: https://jobs.centaurdelivery.com/users/sign_up

Bookmark site for future login: <https://jobs.centaurdelivery.com>

Submit Order:

1. Click on “New Job” in the sidebar menu (upper left corner).
2. Click on “Spot Entry”.
3. Fill in the ISCI, Title, Advertiser and Destinations.
4. Click “Submit Order”.

Upload Spots:

1. Click on “Videos” in the sidebar menu. Make Filename match ISCI code.
2. Drag your spots into the browser. Alternatively, click “Upload Video” and choose your video.

For Assistance / More Information:

Give us a call: 212-400-1683:

Drop us an email: cinfo@centaurdelivery.com

For more information, please contact Centaur.

Phone: 212-400-1683
www.centaurdelivery.com

Comcast AdDelivery

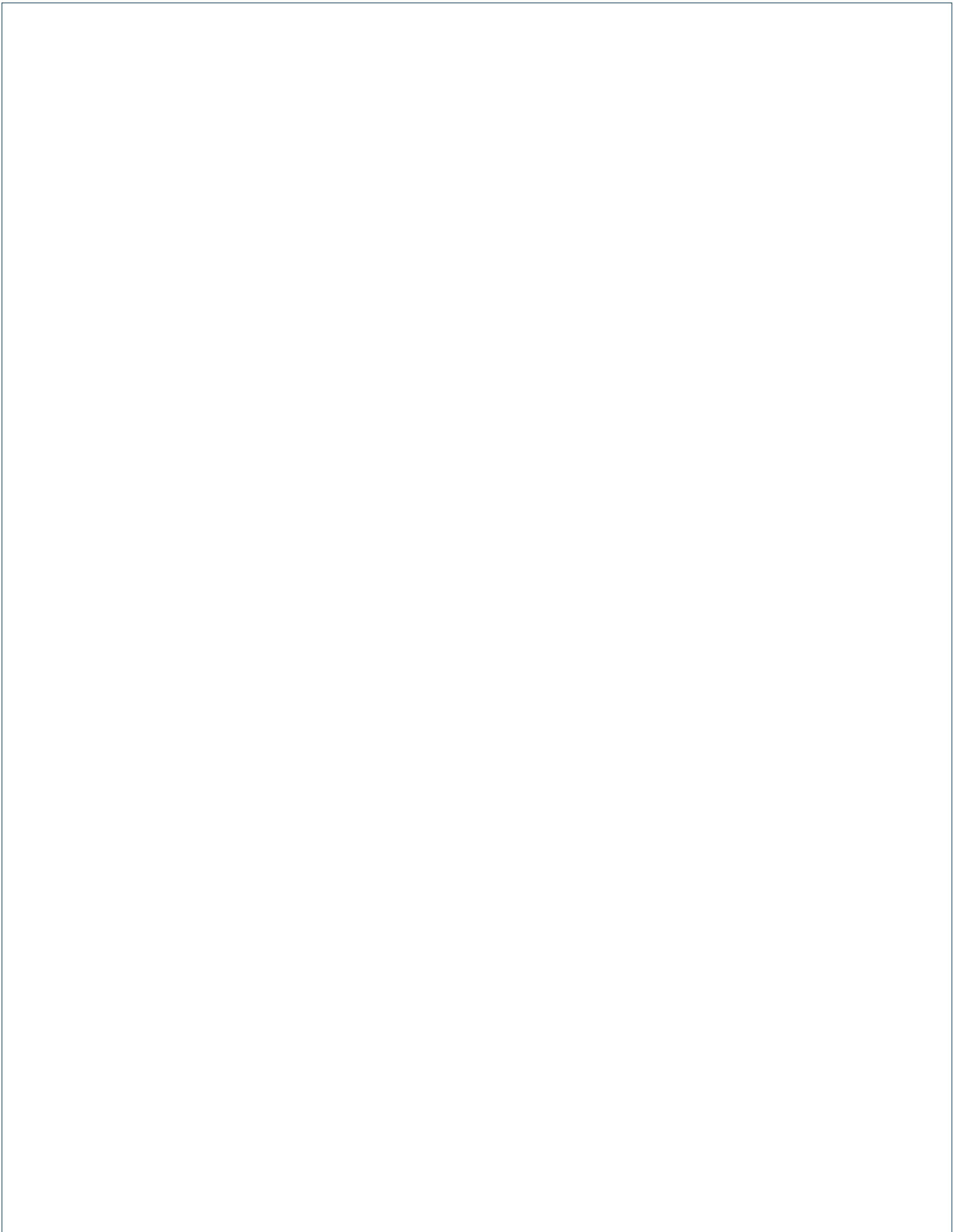

Comcast AdDelivery Lite

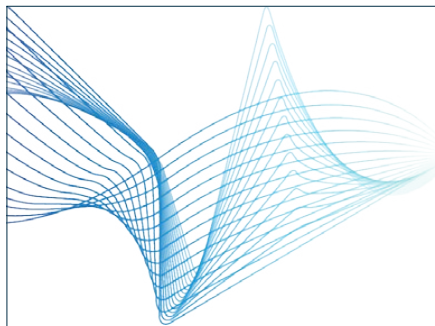

COMCAST TECHNOLOGY SOLUTIONS AD DELIVERY FORMAT SPECS – LITE

The following are the audio and video technical specifications for SD and HD spots submitted to Comcast Technology Solutions.

FILE LAYOUT FOR COMCAST TECHNOLOGY SOLUTIONS

For all SD and HD spots submitted to Comcast Technology Solutions, spots must be submitted at ready to air lengths:

Leading Black	Slate	Black	Spot	Trailing Black
0	0	0	15 sec/450 frames, 30 sec/900 frames, 60 sec/1800 frames, 90 sec/2700 frames, 120 sec/3596 frames, 5 min/8992 frames	0

Spots for Comcast Technology Solutions that are not exact lengths and do not start on first video and end on last video will be rejected. We adjust each outbound transcode to conform to receiver specifications, both audio and video.

SD VIDEO FORMATS

	Recommended Format—MPEG	Quicktime	Quicktime	Quicktime
Stream Type	MPEG-2 Program Stream	Apple ProRes 422	DV/DVCPRO-NTSC, Avid DV/DV50	H.264
Video Bitrate	12 - 30 Mbps (CBR or VBR)	20 - 65 Mbps (VBR)	25/50 Mbps (CBR)	8 - 30 Mbps (CBR or VBR)
Frame Rate	29.97	29.97	29.97	29.97
GOP Structure	Closed GOP	N/A	N/A	N/A
Closed Captioning¹	EIA-608	EIA-608	EIA-608	EIA-608
Chroma	4:2:0	4:2:2	4:1:1 (DV), 4:2:2 (DVCPRO/DV50)	4:2:0
Interlacing	Upper Field First	Upper Field First	Lower Field First	Progressive
Aspect Ratio	4:3	4:3	4:3	4:3
Width/Height	720x480/486	720x486	720x480	720x480/486
Audio Type	MPEG-1 Layer 2	LPCM	LPCM	LPCM
Typical Transfer²	1-5 minutes	2-24 minutes	3-20 minutes	2-6 minutes
Typical Export³	< 1 minute	< 1 minute	< 1 minute	5-15 minutes
Notes	MP@ML, HL, HP@HL	ProRes 422 LT, ProRes 422, ProRes 422 HQ are all acceptable		M@L3, L3.1 are all acceptable

SD AUDIO

	MPEG	PCM
Encoding Type	MPEG-1 Layer 2	LPCM
Number of Channels	2 - Stereo	2- Stereo
Channel 1	Stereo Left	Stereo Left
Channel 2	Stereo Right	Stereo Right
Bit Depth	16	16
Bit Rate	384 Kbps	1536 Kbps
Sampling Rate	48KHz	48KHz
Instantaneous Peak Audio Max	-8dBFS	-8dBFS
Average Peak Audio Max	-10dBFS	-10dBFS
Average Levels	-20dBFS	-20dBFS

HD VIDEO FORMATS

	Recommended Format—MPEG	Quicktime	Quicktime	Quicktime
Stream Type	MPEG-2 Transport Stream	Apple ProRes 422	Avid DNxHD	H.264
Video Bitrate	20 - 100 Mbps (CBR or VBR)	40 - 220 Mbps (VBR)	145/220 Mbps (CBR)	15 – 100 Mbps (CBR or VBR)
Frame Rate	29.97 (1080i), 59.94 (720p)	29.97 (1080i), 59.94 (720p)	29.97	29.97 (1080i), 59.94 (720p)
GOP Structure	Closed GOP	N/A	N/A	N/A
Closed Captioning ¹	EIA-608 and EIA-708	EIA-608 and EIA-708	EIA-608 and EIA-708	EIA-608 and EIA-708
Chroma	4:2:0, 4:2:2	4:2:2	4:2:2	4:2:0
Interlacing	Upper Field First (1080i), Progressive (720p)	Upper Field First (1080i), Progressive (720p)	Upper Field First (1080i), Progressive (720p)	Progressive
Aspect Ratio	16:9	16:9	16:9	16:9
Width/Height ³	1920x1080 (1080i), 1280x720 (720p)	1920x1080 (1080i), 1280x720 (720p)	1920x1080 (1080i), 1280x720 (720p)	1920x1080 (1080i), 1280x720 (720p)
Audio Type	MPEG-1 Layer 2	LPCM	LPCM	LPCM
Typical Transfer ²	2-40 minutes	4-90 minutes	15-90 minutes	2 – 20 minutes
Typical Export ³	< 1 minute	< 1 minute	< 1 minute	30 – 60 minutes
Notes	MP@HL HP@HL	ProRes 422 LT, ProRes 422, ProRes 422 HQ are all acceptable	DNxHD 145, DNxHD 220 are both acceptable	M@L3.1, L3.2, M@L4, L4.1, L4.2 are all acceptable

HD AUDIO

	MPEG	PCM	PCM
Encoding Type	MPEG-1 Layer 2	LPCM	LPCM
Number of Channels	2 - Stereo	2- Stereo	6, 8, or 10
PIDs/Channel per PID	1/2	1/2	3/2, 4/2, 5/2, 1/6, 1/8, 1/10
Channel 1	Stereo Left	Stereo Left	Left Front
Channel 2	Stereo Right	Stereo Right	Right Front
Channel 3		Mono SAP (optional) ⁷	Center
Channel 4		Mono VDS (optional) ⁷	Low Frequency Effects
Channel 5			Left Surround
Channel 6			Right Surround
Channel 7			Lt Stereo (optional) ⁶
Channel 8			Rt Stereo (optional) ⁶
Channel 9			Mono SAP (optional) ⁷
Channel 10			Mono VDS (optional) ⁷
Bit Depth	16	16	16
Bit Rate	384 Kbps	1536 Kbps	1536 Kbps
Sampling Rate	48KHz	48KHz	48 KHz
Instantaneous Peak Audio Max	-8dBFS	-8dBFS	-8 dBFS
Average Peak Audio Max	-10dBFS	-10dBFS	-10 dBFS
Average Levels	-20dBFS	-20dBFS	-2 dBTP

²30s to 2m spot assuming an average bandwidth of 5 Mbps. Use <http://speedtest.comcast.net/> to give you an idea of your bandwidth. 5 Mbps is the suggested minimum bandwidth.

³Estimated time to fully export from Avid or Final Cut Pro.

⁴For MPEG formats, Comcast Technology Solutions supports SD closed captioning in an EIA-608 encoding. For MPEG-TS Supply the EIA-608 encoding in both ATSC A/53 user data and additionally as SCTE-20 user data (for MPEG-PS ATSC A/53 only is required). For QuickTime formats, Comcast Technology Solutions supports SD closed captioning in an EIA-608 encoding stored as a QuickTime closed captioning text track.

⁵For MPEG formats, Comcast Technology Solutions supports HD closed captioning in an EIA-708 encoding in ATSC A/53 user data. An additional EIA-608 encoding, also as ATSC A/53 user data, is required for backwards compatibility reasons. For QuickTime formats, Comcast Technology Solutions supports closed captioning in an EIA-708 encoding as a QuickTime closed captioning text track. An additional EIA-608 encoding also within a QuickTime closed captioning text track is required for backwards compatibility reasons.

⁶When sending 5.1 audio, the Lt/Rt pair is optional and we will automatically create the pair as a mix down of the 5.1 channels. If the Lt/Rt pair is included then we will use those and not create a mix down. Both sides of the pair must be included. If you do *not* have Lt/Rt pair do not send these channels as silence, but rather do not include these channels.

⁷Any audio on channel 3,4 when sending stereo or channel 9,10 when sending 5.1 is assumed to be SAP and VDS. If you do *not* have SAP *and* VDS do not send these channels as silence, but rather do not include these channels. If you have SAP *or* VDS then include both channels but make the one you don't have silent (even throughout the slate - no beeps or tone during the slate).

⁸Comcast Technology Solutions adheres to SMPTE RP 2046-2 - title safe areas should be 90% of the width and 90% of the height of the part of the image to be extracted. Comcast Technology Solutions determines duration based on 29.97 DF regardless of source media frame rate. All content delivered over :120, should be edited and uploaded using DF.



For questions on spots, contact Comcast Technology Solutions
Customer Support at 855-858-1942

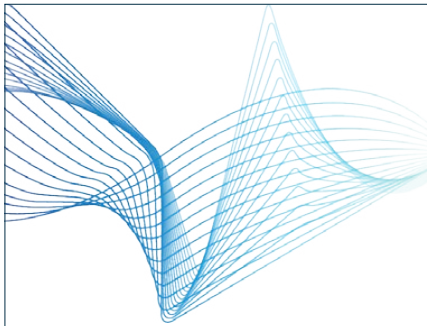

COMCAST TECHNOLOGY SOLUTIONS SPOTLIGHT UPLOAD STEPS

Comcast Technology Solution's Spotlight product is a free self-registering product so upload to Comcast hubs is a couple quick steps:

1. Register your email at: <https://login.comcastaddeliverylite.com>
2. Once registered you will immediately be able to upload using this Comcast Technology Solutions Product.

3. **SUBMIT SPOTS:** Enter in the appropriate metadata for the fields that present themselves; client name, agency name, etc.
4. **UPLOAD SPOTS:** Browse for your spot and upload. (Please use the audio and video specifications that can be found [here](#). Please note, you'll need to log in to the ad delivery support portal to view.)
5. After you **SUBMIT**, scroll down to view the "Active Submits" section. This section details several process steps as it works through delivery. You can continue to upload more spots while others are uploading.
6. **VIEW MEDIA:** Click the **VIEW** tab page to see account history that records delivered media.
7. Once delivery is complete, you will receive an automated notification from noreply@comcastaddeliverylite.com that the Comcast hub you selected has received the content. If your spot was rejected, you will receive a rejection notification detailing the issue.
8. Any issues or questions, please reach out to our Support Engineers for this product: 1-855-858-1942. Addelivery_support@cable.comcast.com

Extreme Reach

Master Video File Specifications

Extreme Reach provides multiple solutions for uploading creative assets to your account. Whether you choose to upload spots via the Media Uploader Application or through the web-based platform, all files must meet the specifications in this document before they can be accepted.

To help ensure that your files are seen and heard exactly as you intend them to be, please review and follow the detailed specifications below. **Verifying the playback of your final digitized files locally prior to uploading to Extreme Reach is imperative.**

File Naming

The file name should be the Ad-ID with the file extension at the end (e.g., ZYWX9876000H.mpg or ZYWX9876000H.mov). If you're not using Ad-ID, file names should follow these guidelines:

- File names can only contain letters and/or numbers (special characters are not allowed).
- HD file names must end in an "H" and the SD file name must match the HD file name with the exception of the "H" (e.g., ZYWX9876000).
Note: In Canada, the "H" is not a requirement for HD spots.
- To avoid any potential rejections from video destinations, keep file names to 12 characters or fewer for HD, and 11 for SD. See sidebar for specific restrictions.

Restrictions

- CBS allows up to 12 characters for SD or HD
- ABC allows up to 12 characters for SD and up to 13 characters for HD
- NBC allows up to 15 characters for SD and HD
- FOX allows up to 15 characters for SD and HD
- ESPN allows up to 18 characters for SD and HD
- AT&T AdWorks allows up to 20 characters for SD and HD
- Discovery allows up to 25 characters for SD and HD

Content Layout

All files must adhere to this configuration before uploading to the Extreme Reach platform.

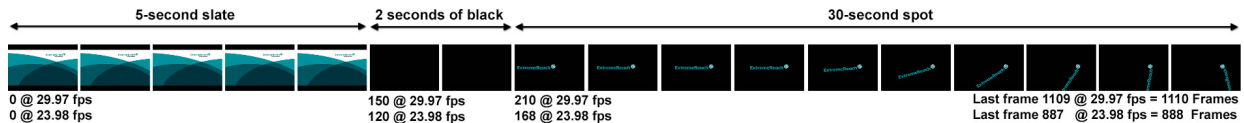

5 SECONDS OF SLATE

Ad-ID must be present on the slate. If you use "/H" then the same slate can be used for HD and SD.

NO AUDIO ON SLATE

There should be no audio in the slate, however, a 2-pop at the end of the slate is acceptable as long as it does not exceed -20 dBFS.

START FRAME

The spot must start on frame 210 for 29.97fps or frame 168 for 23.98fps. The creative content must run to the last frame of the spot with no black at the tail (unless the black is part of the content). There should be no extra frames after the creative.

These specifications must be met exactly to ensure compliance with the video destination's requirements.

For example, a correctly-formatted 30-second spot will have a total duration of 37 seconds (including slate and black) and a total of 1110 frames at 29.97fps or 888 frames at 23.98fps. This means the start of the spot will be at the 7-second mark and there is no black after the spot.



Audio Levels

These specifications are in accordance with ATSC RP A/85 and measured as per ITU-R BS. 1770-3.

TARGET LOUDNESS LEVEL SHOULD BE -24 LKFS

Minor measurement variations up to approximately ± 2 dB from this value are anticipated due to measurement uncertainty, and are acceptable.

TRUE-PEAK LEVEL SHOULD BE BELOW -2 dB TP

This provides headroom to avoid potential clipping due to downstream processing.

The target loudness level should not be -22 LKFS or -26 LKFS.

In order to provide consistent audio levels, any content that does not conform to the -24 LKFS loudness level may be normalized by Extreme Reach to meet the loudness requirement. This internal process will shift the average loudness to -24 LKFS with no impact to dynamic range. If the content is too far outside of these requirements or cannot be normalized correctly for any reason, Extreme Reach may require a re-submission.

Video Levels

When measured on a digital scale (SDI Hardware/Internal NLE meters):

Black level = 0% / 0mV

White level = 100% / 700mV

RGB = 0% - 100% / 0mV - 700mV

Suggested Standards

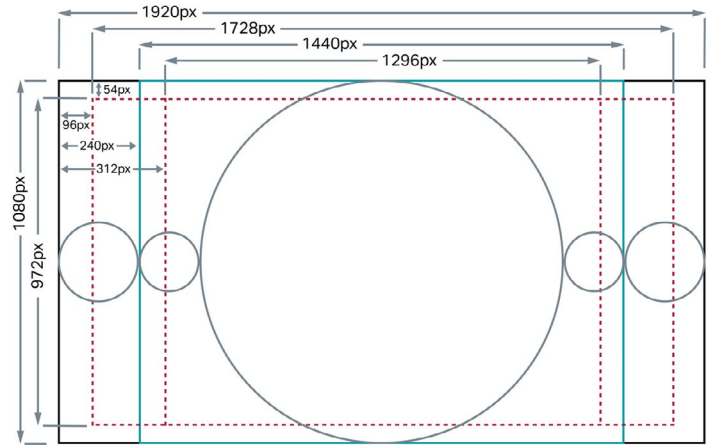

SAFE TITLE AREA

The safe title area is 90% of the width and 90% of the height of the production aperture. These specifications are in accordance with SMPTE ST 2046-1 and SMPTE RP 2046-2.



CENTER CUT PROTECTION

The center cut protected area is 90% of the width and 90% of the height of the 4:3 aperture. All graphics, text and frame composition elements should be placed within the center cut protected area to prevent key content from being cut-off when downconverted to SD.



Audio Specifications

AUDIO TYPE

	MPEG	PCM
Type	MPEG-1 Layer 2	SMPTE 302M
Channels	2 channels	2 channels or 8 channels

CHANNEL CONFIGURATION

	Stereo (MPEG or LPCM)	5.1 Surround plus Stereo (LPCM)
Channel 1	Stereo Left	Left Front
Channel 2	Stereo Right	Right Front
Channel 3		Center
Channel 4		Low Frequency Effects
Channel 5		Left Surround
Channel 6		Right Surround
Channel 7		Stereo Left
Channel 8		Stereo Right

High Definition File Specifications

	MPEG (*.mpg)	ProRes (*.mov)	Avid (*.mov)	MXF (*.mxf)
Stream Type	MPEG-2 Transport Stream (422@HL, HP@HL)	Apple ProRes 422 (HQ) Apple ProRes 422 (LT) can be used if bandwidth is limited	AVID DNxHD 220 AVID DNxHD 175 AVID DNxHD 145 AVID DNxHD 115	XDCAM HD 422
Video Bit Rate	45 Mbps (constant)	Default	Default	50 Mbps
GOP	Long GOP	Default	Default	Long GOP
Frame Rate	23.98 (1080p) or 29.97 (1080i) or 59.94 (720p)			
Aspect Ratio	16:9			
Pixel Aspect Ratio	Square			
Width/Height	1920x1080 (1080p) or 1920x1080 (1080i) or 1280x720 (720p)			
Chroma	4:2:2			
Interlacing	1080p (progressive) or 1080i (upper/top field first) or 720p (progressive)			
Audio Type	MPEG-1 Layer 2	PCM	PCM	PCM
Audio Sample Rate	48kHz			
Audio Bit Depth	N/A	16 bits or 24 bits		
Audio Bit Rate	384 Kbps	Uncompressed	Uncompressed	Uncompressed

Standard Definition File Specifications

	MPEG (*.mpg)	ProRes (*.mov)	Avid (*.mov)	MXF (*.mxf)
Stream Type	MPEG-2 Program Stream or Transport Stream (422@ML, HP@ML or HP@HL)	Apple ProRes 422 (HQ) Apple ProRes 422 (LT) can be used if bandwidth is limited	Avid Meridien Compressed	XDCAM IMX 50 XDCAM IMX 35 XDCAM IMX 25
Video Bit Rate	20 Mbps (constant)	Default	35 Mbps (2:1)	50, 35 or 25 Mbps
GOP	Long GOP	Default	Default	Default
Frame Rate	29.97fps or 23.98fps			29.97fps
Aspect Ratio	4:3			
Pixel Aspect Ratio	9:10 (D1 Pixels)			
Width/Height	720x512 or 720x480	720x486 or 720x480	720x486 or 720x480	720x512 or 720x480
Chroma	4:2:2			
Interlacing	SD content can be upper/top or lower/bottom field first or progressive (23.98fps files must be progressive)			Upper/Top field first
Audio Type	MPEG-1 Layer 2	PCM	PCM	PCM
Audio Sample Rate	48kHz			
Audio Bit Depth	N/A	16 bits or 24 bits		
Audio Bit Rate	384 Kbps	Uncompressed	Uncompressed	Uncompressed

Closed Captioning

- When sending spots with closed captions, masters must be sent with a frame rate of either 29.97fps or 59.94fps (23.98fps currently is not supported).
- For MPEG files, CEA-608 and CEA-708 data must be compliant and present if a spot is closed captioned (SMPTE 436M for MXF file types and QuickTime closed captioning track for MOV file types).
- SD formats with embedded CEA-608 closed captioning data and QuickTime closed captioning track for MOV files are accepted. Line 21 captions are only accepted on 720x486 and 720x512 formats.
- MPEG SD 720x512 with Line 21 captions must be upper/top field first.
- QuickTime SD 720x486 with Line 21 captions must be lower/bottom field first.
- The first caption should be “paint-on” and occur on or after the fifth frame of content or there must be a one-second delay if the first caption is “pop-on.”
- All spots intended for broadcast in Canada must contain closed captioning.
- If a spot is closed captioned, it must be indicated in the metadata and should be included on the slate.

Contact us at support@extremereach.com or 800.324.5672 for a more personal discussion regarding your workflow and needs.

©2018 Extreme Reach Inc. All rights reserved. 201810 extremereach.com





How to Add and Upload New Assets

EXTREME REACH MAKES IT EASY TO ADD AND UPLOAD CREATIVE ASSETS.

We handle spot delivery based on each destination's specifications. Make sure all of your files follow the detailed specifications in the [Extreme Reach Master File Specifications](#) document to be accepted. This helps ensure that your video files are seen and heard exactly as you intend them to be.

Common Video Issues

If your assets are video files, verifying the playout of your final digitized files is very important prior to uploading to the Extreme Reach platform. Common issues include:

- Incorrect 5.1 audio configuration. Common issue is lack of voiceover on Channel 3.
- Video glitches that sometimes occur when video files are rendered from the editing system or during capture of source material.
- Extra frames at the beginning or end of a spot (i.e. proper timing).
- Inaccurate slate information, such as incorrect Ad-ID, Audio configuration, etc.
- Audio Content (i.e. Stereo or Dual Mono). Final mix is a creative decision; always verify your audio is set as Stereo unless Dual Mono is the specific audio mix desired for your approved spot.

Add an Advertiser

If you have not yet done so, you will need to create an advertiser in the platform before uploading and assigning video creative.

1. Mouse over **Account** at the top right and click **Advertisers**.
2. Complete the top section of the page to add a new advertiser and click **Add Advertiser**.
3. Your new advertiser will then show in the list below along with all advertiser profiles accessible on your account.
4. Click the page action icon to edit you advertiser details. The arrow icon allows you to share the advertiser.

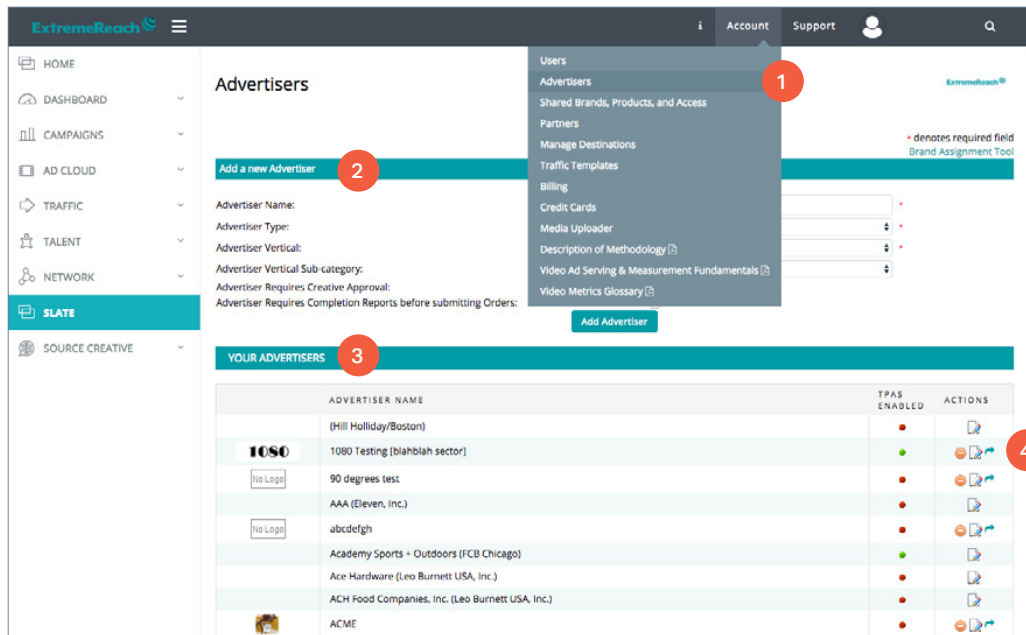

Add New Asset

1. In the left hand menu, click **Ad Cloud**, then **Add New Asset**.
2. Select the appropriate **Advertiser** from the drop-down list.
3. Click **Add** for a pop-up screen to add a new asset for the Advertiser.

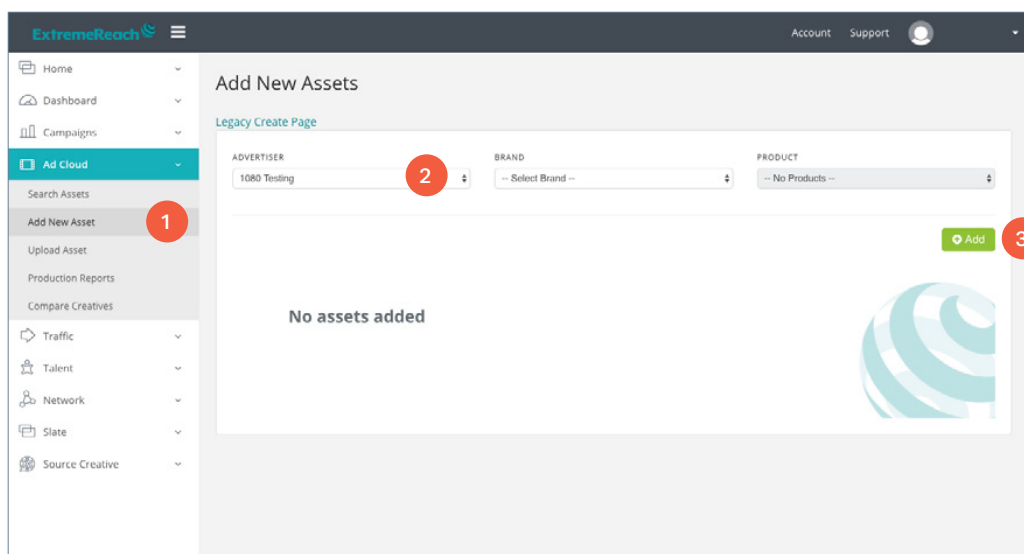

4. Add details about your new asset. Ad Code, Title, Length and Type of file are required fields.
5. When a Video Type is selected, additional detail options show in the grey box below.
6. If the spot is High Definition (HD) and you check off the box, further details are required below it.
7. Indicate if Production Services are **Applied** or **Need to Be Applied** to the spot. Choose **Applied** if you're uploading a spot with closed captioning or encoding. The available encoding types are: SpoTTrac, TeleTrax, Tivo, and Veil. Select **Need to Be Applied** if you would like Extreme Reach to apply closed captioning or encoding.
8. Click on **Advanced** and/or **Notes** to show more. Click **Add to List** to add the new asset.

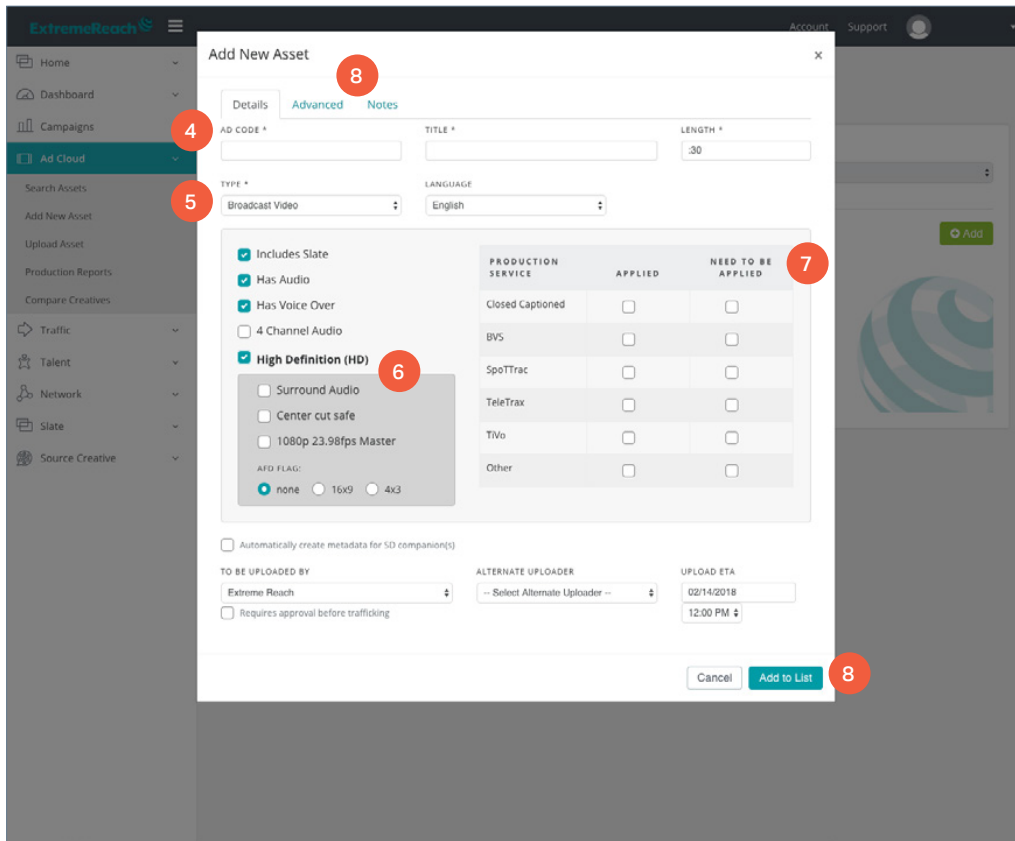

Asset Upload

1. In the left hand menu, click **Ad Cloud**, then **Upload Asset**.

1a. Click on the **Extreme Reach Master File Specifications** to double check that your files are correct before uploading.

Note: You can add a new asset right from this page by clicking on the **Create Asset** button.

2. Select the appropriate **Advertiser** from the drop-down list.

3. Click **Advanced** for additional search features (Title; Media Type; ISCI/Ad-ID) to show below.

4. Once **Advertiser** is selected, search results will populate below.

5. Click on an **Ad Code** to show its **Asset Details** page.

6. Click on **Select File** for a pop-up screen to upload a new file(s) for that asset.

The screenshot shows the 'Asset Upload' page in the Extreme Reach system. The left-hand navigation menu has 'Ad Cloud' selected, and 'Upload Asset' is highlighted with a red circle '1'. The main content area is titled 'Legacy Upload Page' and contains several search filters: 'Advertiser' (set to '1080 Testing' with a red circle '2'), 'Brand' (set to '-- Select Brand --'), and 'Product' (set to '-- No Products --'). Below these are 'Advanced' search options (with a red circle '3') for 'Title', 'Media Type' (set to '-- All Media Types --'), 'ISCI / AD-ID', and 'HOUSENUM'. A 'Search' button and a 'Clear Search' button are present. To the right of the search filters is a link for 'Extreme Reach Master File Specifications' with a '+ Create Asset' button (with a red circle '1a'). Below the search filters is a table of search results (with a red circle '4') showing columns for 'AD CODE', 'TITLE', 'LENGTH', 'TYPE', 'FILE', and 'UPLOAD OPTIONS'. The table contains three rows: 'TEST1234QADASFEW' (test, :30, Broadcast Video, No File Selected), 'MONICATESTH' (60fps Test, :15, Broadcast Video, No File Selected), and 'TEST5QLRP0092' (TEST MXF for North Country, :50, Broadcast Video, No File Selected). The 'MONICATESTH' row has a red circle '5' over the 'AD CODE' and a red circle '6' over the 'Select File' button in the 'UPLOAD OPTIONS' column.

6a. Drop your file(s) into the space provided or click Add File(s) for a dialogue box.

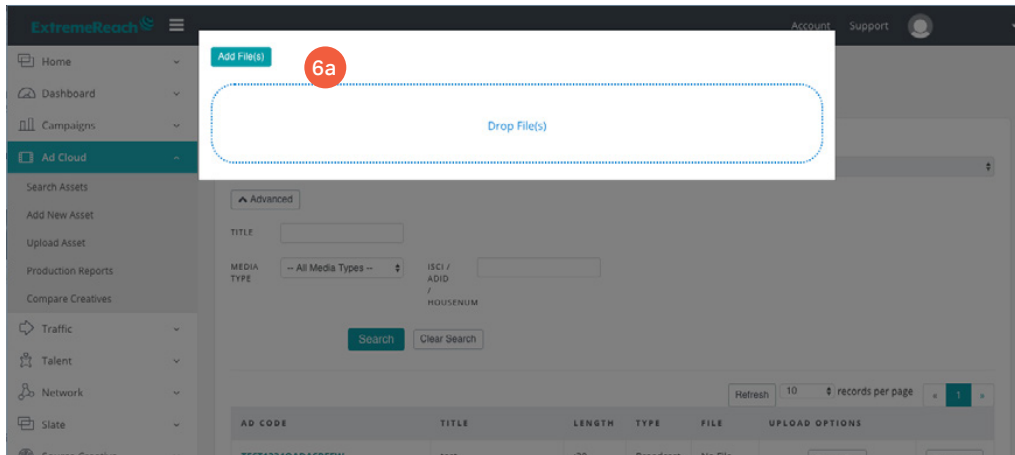

6b. You will be returned to the main Upload page and have the option to **Start Upload** or **Remove Attachment**.

6c. Once file is uploaded successfully, you will see the icon noted below.

7. If necessary, click on **Edit Asset** for a pop-up screen to update or add asset details.

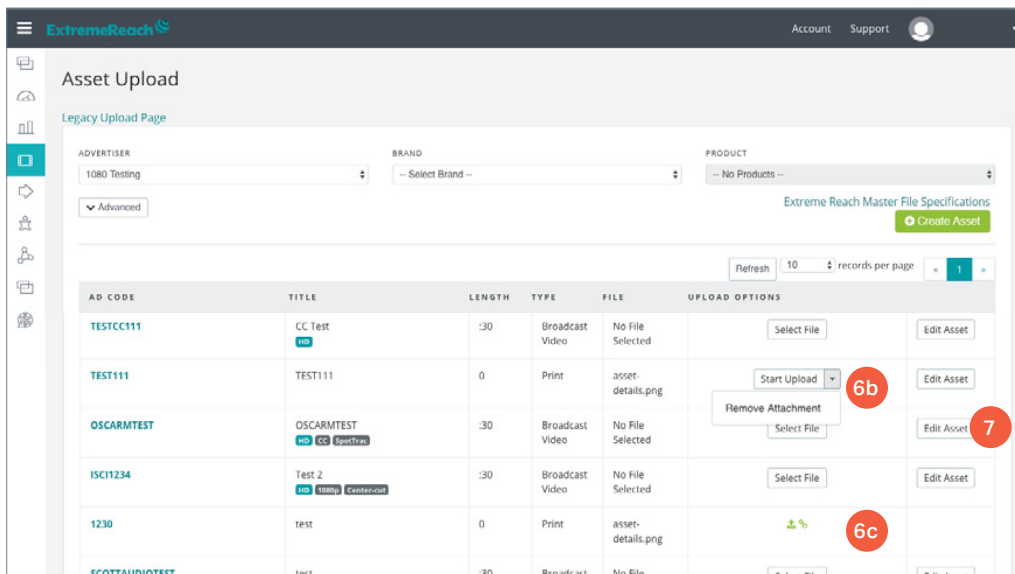

Contact us at support@extremereach.com for a more personal discussion regarding your workflow and needs.

©2018 Extreme Reach Inc. All rights reserved. 201802 extremereach.com



Javelin / Adstream

adstream

Master File Specifications

Production Slate Contents

- Ad-ID or ISCI
 - Title
 - Length
 - Production Date
- Do Not** include Resolution/Frame Rate Standard

Linear Format – Content Timeline

- Pre-Black – 2 sec
- **SLATE** – 5 sec
- Post-Slate Black – 2 sec
- **SPOT** - :15, :30, :60
- Post-Black – 1 sec

Standard Definition (SD)

Video Specs

Stream Type: QuickTime Extension: .mov
Codec: Apple Pro Res 422 (HQ)
Resolution: 720 X 486 (PAL: 720 X 576)
Aspect: 4:3
Frame Rate:
29.97 fps (NTSC)
25 fps (PAL)

Frame Rate Mode: Constant
Field Type:
NTSC – Lower Field/Interlaced
PAL – Upper Field/Interlaced

Color Space: YUV
Chroma Subsampling: 4:2:2
Quality: Best / 100%
RGB Levels: 100%/RGB or less
White Levels: 0-700mv (+2% max 714mv)

Audio Configuration

Audio codec: PCM
Channels: Stereo
Sample Type: 24 bits
Sample Rate: 48KHz (Preferred)
Levels: LKFS -24; Avg. -20db/Peaks -6db

High Definition (HD)

Video Specs

Stream Type: QuickTime Extension: .mov
Codec: Apple Pro Res 422 (HQ)
Resolution: 1920 x 1080
Aspect: 16:9
Frame Rate:
Preferred: 23.98 fps
Accepted: 29.97 fps NDF
PAL Only: 25 fps (50i)

Frame Rate Mode: Constant
Field Type:
23.98 – Progressive (PSF)
29.97 – Upper Field/Interlaced
25 – Upper Field/Interlaced

Color Space: YUV
Chroma Subsampling: 4:2:2
Quality: Best / 100%
RGB Levels: 100% / RGB or less
White Levels: 0-700mv (+2% max 714mv)

Audio Configuration

Audio codec: PCM
Channels: Stereo or 5.1
Sample Type: 24 bits
Sample Rate: 48KHz (Preferred)
Levels: LKFS -24; Avg. – 20db/Peaks – 6db

adstream

Radio Specs

- .MP3 Stereo
- 44.1khz, 256kbps, Slates optional

Closed Captioning (If spots being provided will have CC, they must adhere to the formatting below)

- SD Line 21 Captions must be embedded into line 21 and 608 captions must be present.
- HD 608 and 708 data must be present.

Aspera Upload Information (Preferred Option)

For assets being uploaded electronically to Adstream, please follow the steps below:

1. Download and install the client applet at:
<http://www.asperasoft.com/download/sw/connect/AsperaConnect>
2. Once installed, go to: <https://upload.javelindelivers.com> (ip 52.9.221.151)
(FASP port: UDP/TCP 33001)

Login Information:

Username: adstream-na
Password: ivei^Naef3

3. Once logged in click on **“upload”**.
4. Choose your file(s) to upload, send will start automatically.
5. Adstream receives automated notification of any upload to this account.

Support

Los Angeles

Email: NA.AccountServicesLA@adstream.com
Phone: (818) 860-0410

On The Spot



Advertisement Specifications and Submission Procedure

page 1 of 2

File Name and ISCI Code/Ad-ID Requirements

The file name should be the ISCI code or Ad-ID followed by the file extension ex: .mpg, .mov. As an example a spot with ISCI Code ISCI1234 in a QuickTime container would be named ISCI1234.mov. A valid ISCI code or AD-ID is required for all advertisements and must not exceed 12 characters. HD advertisements must have an ISCI code or Ad-ID ending with an H ex: ISCI1234H.

File Encoding Guidelines

Our primary goal is to distribute the highest quality content possible. To that end we request that customers upload the highest quality file they can provide that we are able to process. Each file format must go through our QC testing process to ensure compatibility with our systems. We can process a wide variety of formats, including but not limited to the following containers and codecs:

Apple Pro Res | MPEG 2 | MXF

Files for broadcast distribution should be submitted with a frame rate of 29.97. Frame rate conversions are available as an additional production service charge.

To enquire about additional supported formats please email operations@onthespotmedia.com.

Hard Copy Formats

Digital BetaCam | DVC Pro | DV Cam | Mini DV | BetaCam SP | DVD
HD Cam SR | HD Cam | D5 | DVC Pro HD | XDCAM

High Definition Audio Channel Mapping

Stereo Only

Stereo Mix on Channels 1-2

Surround W/ Stereo Mix

Surround on Channels 1-6

(Left Front, Right Front, Center, Low Frequency Effects, Left Surround, Right Surround)

Stereo Mix on Channels 7-8

Audio Levels, Loudness and CALM Act Compliance

Audio levels should be CALM Act compliant with a loudness level of -24LKFS +/- 2dB. If your facility does not have the ability to meter in LKFS accurately please use the following guidelines to obtain an acceptable audio level within proper range of broadcast requirements. Every spot will be subjected to an audio loudness processing to ensure CALM Act compliance prior to distribution at no additional cost.

Digital Audio Levels Using dBFS Scale

10dbfs = Digital audio levels should not peak higher than -10dbfs (+/- 1dbfs)

Digital Peak Meters are found on digital broadcast equipment, VTR's and NLE editing systems

Analog Audio Levels Using VU Scale

0 dB = Analog audio levels should not peak higher than 0dB (+/- 1dB)

Analog audio levels can be metered using a standard analog VU meter

HD Center Cut Protect and 4:3 Title Safety Requirements

HD content must be "Center Cut Safe" and "4:3 Title Safe" while SD requires only "4:3 Title Safety" to ensure creative and legal information is not cropped in a down converted feed. Important creative and legal information includes but is not limited to, phone numbers, website URL's, disclaimers, Logo's as well as other important text and graphics.

On The Spot Media • 228 E 45th St, 6th Floor, New York, NY 10017 • 855-855-OTSM • www.onthespotmedia.com



Advertisement Specifications and Submission Procedure (con't)

Closed Caption Formatting and Encoding Specifications

We support and process accurately the following closed captioning data, "Line 21" VBI Captioning in files with a frame size of 486i or greater, QuickTime Closed Captioning Tracks in all versions of QT files, MPEG2 Captioning typically encoded as "Picture User Data".

Linear Formatting Requirements

Each advertisement should be exported as a individual file. Files must adhere to one of the following combinations:

Order of Content	Seconds	Frames
Slate	2 Seconds	60 Frames
Black and Silence	2 Seconds	60 Frames

Followed by

:10 Second Creative	10 Seconds	300 Frames
:15 Second Creative	15 Seconds	450 Frames
:30 Second Creative	30 Seconds	900 Frames
:60 Second Creative	60 Seconds	1800 Frames

Followed by

Black and Silence	1/10th Second	3 Frames
-------------------	---------------	----------

Advertisements longer than :60 seconds / 1:00 minute follow the same structure. Total frame count can be determined by simply adding together two or more of the counts from the creative portion of the above table. For example a 1:30 minute advertisement would have a total of 2700 frames.

Slate Requirements

Each individual spot/file must have a slate before the start of picture. A slate is a still video segment with standard information required by broadcasters for identification. The slate at a minimum will contain the Client, Advertiser, Product, Title, ISCI or Ad-ID (12 character max), and Length.

Testing Guidelines and Uploading Instructions

Prior to sending content for distribution, all new clients must send test files for QC analysis and approval. This allows us to perform and communicate our quality control procedures and attend to all potential issues ahead of time. After testing is complete, we can setup customer specific FTP login credentials for live orders. The goal of the testing phase is to develop a repeatable process that can be automated to accelerate distribution.

Quality Control Procedure

In addition to File-Based analysis to ensure file integrity, we visually inspect and approve all incoming masters for distribution. We will hold content and request approval prior to distribution if there are action safe, center cut safe, closed captioning, slating, picture quality and/or, linear formatting concerns. If you have content you suspect will be flagged, pre-approval can be arranged by contacting clientservices@onthespotmedia.com prior to submission.

Send Hard Copies To:

Operations Department
On The Spot Media
228 East 45Th Street, 6th Floor
New York, NY 10017

FTP Upload URL and Login:

URL: <ftp2.onthespotmedia.com>
Username: NewClient
Password: 2TT1NS1S

On The Spot Media

228 E 45th St, 6th Floor, New York, NY 10017
P: 855-855-OTSM (6876)
P: 917-546-9299
F: 917-546-9278
www.onthespotmedia.com
clientservices@onthespotmedia.com

On The Spot Media • 228 E 45th St, 6th Floor, New York, NY 10017 • 855-855-OTSM • www.onthespotmedia.com



OneSpot.tv



Introducing OneSpot.tv

Exciting enhancements to our video uploading process

Spectrum Reach's new OneSpot.tv uploader allows you to upload your assets to just one location!

Increase Efficiency - upload all your assets at one time, to one central location

Upload Confirmations - confirmation emails verify spot delivery and allow easy sharing of upload information with sales and traffic teams.

Cost efficient – Free of cost for you!



Access Spectrum Reach's OneSpot.tv uploader: www.onespot.tv/upload.aspx

NEW LOCATION

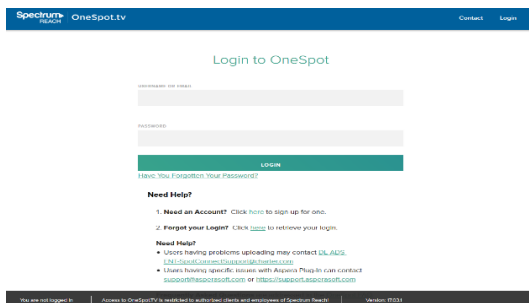

Login to OneSpot.tv

First time user? Easily create a login here.

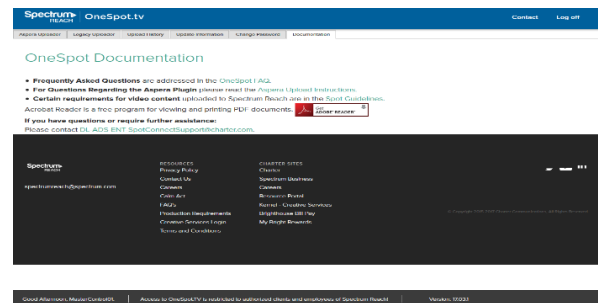

Documentation Information

Specs and How To information

Uploading your assets to Aspera within the **Aspera Uploader** tab

UPLOADING SPOTS

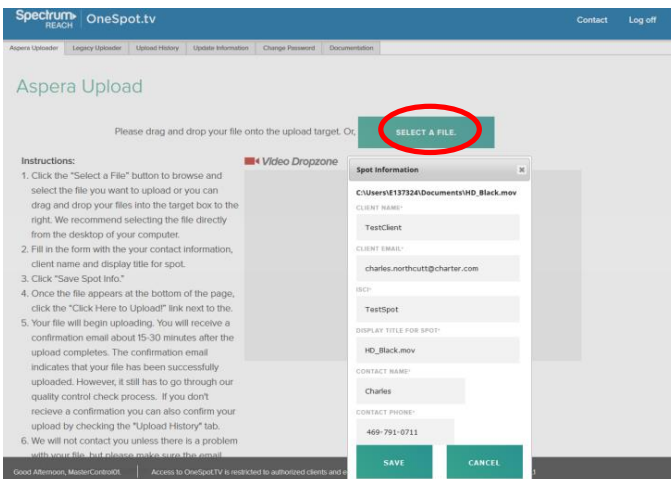

Select a File To Upload

Complete the "Spot Information Box" and save spot info.

Allowed characters in filenames (no blanks or hyphens):

- Alpha (upper or lower, a-z or A-Z)
- Numeric (0 – 9)
- Underbar (_)
- Period (.)

Select More Files or Upload

Your spot will be listed at the bottom of the page. Click "Select file" to add more or select "Click here to upload!"

Upload

Once you select "Click here to upload!", the above message appears. Select "Allow".

Keep in mind your upload history may take up to 20mins to appear.

Need Help? Users who experience problems uploading may contact DL-ADS-ENT-SpotConnectSupport@charter.com.

Users having specific issues with Aspera Plug-In can contact support@asperasoft.com or <https://support.asperasoft.com>

OneSpot Uploader

Please follow the directions below to upload your spot directly to Time Warner Cable Media.

Time Warner Cable Media's online uploader is available at <https://www.onespot.tv/>

It's free, quick, convenient, easy and requires a few simple steps:

1. **Already have an account?**
 - A. Enter your login and password.
2. **Don't have an account?**
 - A. Click the "here" link next to the "Need an Account?" option to the right of the login fields.
 - B. Follow the steps to create your own account. Your credentials will be active immediately.
3. **Once you have signed in to your account, you will be prompted to download the Aspera application(only required on the initial login).**
4. **You can refer to the Documentation tab at the top for recommended file spec information (Spot Requirements Instructions) and instructions for allowing your computer to work with the Aspera application (Aspera Upload Instructions).**
5. **Do NOT use spaces, dashes or special characters in the filename (&,* ,^,%,\$), please just use letters, numbers and underscores.**
6. **Click the green "Select File" button to browse and select the file you want to upload – we recommend selecting the file directly from the desktop of your computer. You may try dragging and dropping your file to the "Video Dropzone", be aware this function may not work with every web browser.**
7. **Fill in the form with **your** contact information, client name and display title for spot.**
8. **Click "Save Spot Info."**
9. **Once the file appears at the bottom of the page, click the "Click Here to Upload!" link.**
10. **Your file will begin uploading. You will receive a confirmation email about 15-30 minutes after the upload completes. The confirmation email indicates that your file has been successfully uploaded. However, it still has to go through our quality control check process.**
11. **We do not contact you unless there is a problem with your file. So please make sure the email address and phone number you input are accurate.**

For troubleshooting assistance contact Master Control at 704-973-7443 or astroc.mastercontrol@twcable.com

SpotGenie



TV SPEC SHEET

<http://static.spotgenie.com/specsheet/>

Layout:

All content should follow this layout:

5 Seconds of Slate (Agency Name, Client Name, ISCI Code, Title)

2 Seconds of Black (00:00:05:00 – 00:00:06:29)

Content (00:00:07:00)

3 frames of Black

Audio levels should be CALM Act compliant

File Naming Conventions:

File names must be named by ISCI only.

Example: ABCD1234.mov

Please exclude dashes, spaces or underscores.

HD files should include an 'H' on the end, and have the same ISCI as their SD counterpart.

Example: SD: ISCI1234, HD: ISCI1234H

Compression:

SD Ideal file format:

Video:

720x486

Apple ProRes 422 HQ

29.97 fps NDF

Interlaced Bottom-Field First

Audio:

Levels should be CALM Act compliant

Linear PCM format (Uncompressed)

SD Acceptable File Format:

Video:

720x486

H.264 (Quicktime wrapped)

@ 45Mbps VBR

29.97 fps NDF

Interlaced Bottom-Field First

Audio:

Levels should be CALM Act compliant

Linear PCM format (Uncompressed)

HD Ideal File Format:

ALL HD SPOTS MUST BE
[CENTER CUT PROTECTED](#)

Video:
1920x1080p
Apple ProRes 422HQ
23.98 fps or 29.97 fps
Progressive Scan
Audio:
Levels should be CALM Act compliant
Linear PCM format (Uncompressed)

HD Acceptable File Format:

ALL HD SPOTS MUST BE
[CENTER CUT PROTECTED](#)

Video:
1920x1080p
H.264 (Quicktime wrapped)
@ 75Mbps VBR
23.98 fps or 29.97 fps
Progressive Scan
Audio:
Levels should be CALM Act compliant
Linear PCM format (Uncompressed)

Audio Layout:

Stereo Layout
Track 1 - Left
Track 2 - Right

or, if available

Surround Layout:
Track 1 - Front Left
Track 2 - Front Right
Track 3 - Front Center
Track 4 - LFE
Track 5 - Back Left
Track 6 - Back Right
Track 7 - Stereo Left
Track 8 - Stereo Right

Captions:

Captions must start at 00:00:00:00
Captioned spots must have a 29.97 frame rate

Upload:

drop.spotgenie.com

Please email csr@spotgenie.com with ISCI codes, title and length of the spots that you will be uploading. This will ensure timely processing of your material.

If you have any questions, email support@spotgenie.com.

Yangaroo



Quick Reference Guide

Creating a Delivery Order for Altice

Quick Reference Guide: Creating a Delivery Order for Altice

Yangaroo, Inc.
253 West 35th Street, Suite 200
New York, NY 10001
1.866.992.9902

Orders: orders@yangaroo.com **Support:** adsupport@yangaroo.com

Contents

Uploading a Spot	3
Creating a Delivery Order	6
Adding Traffic to an Order	9
Getting Help	10

Copyright 2015 Yangaroo, Inc.

Yangaroo, Inc.
253 West 35th Street, Suite 200
New York, NY 10001
1.866.992.9902
Orders: orders@yangaroo.com
Support: adsupport@yangaroo.com

Quick Reference Guide: Creating a Delivery Order for Altice

Uploading a Spot

1. Log in to your account at dmds.me/cms.

Please Note Altice no longer accepts SD content.

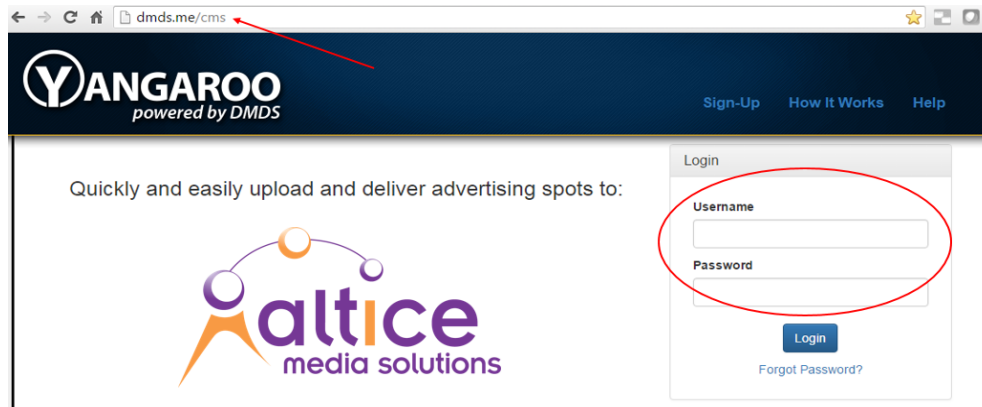

2. Click the **Manage** button and then select **Media Manager**.

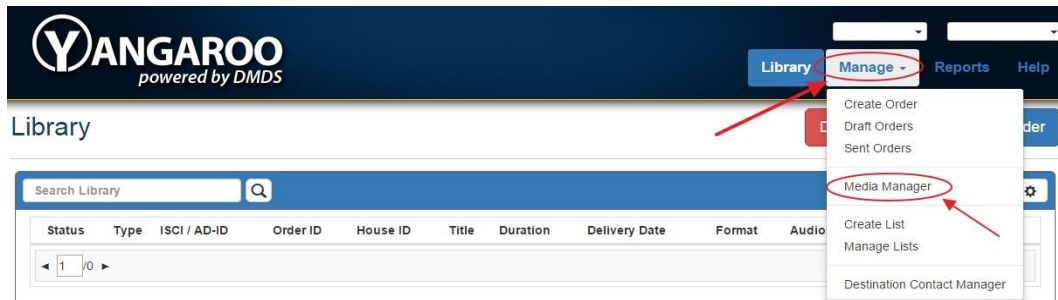

3. Click the **Upload Asset** button.



4. If this is your first time uploading a file, you may be prompted to install the Aspera Connect browser plugin. Download the appropriate version, run and complete the installation, and click **Recheck Plugin status**.

Quick Reference Guide: Creating a Delivery Order for Altice

Upload Video

Aspera Connect is required in order to upload to this site. It is a free plugin that will also increase your upload speeds. Please choose click on a download link, then run the installer and refresh the page and re-open the upload window.

[Recheck Plugin Status](#) [Download Windows Version](#) [Download OSX Version](#)



Sometimes after installing the plugin and rechecking the plugin status, the plugin still is not detected. If that happens, close your web browser and start at Step 1 again.



You may need to give the Aspera Connect plugin permission to run. Look for a prompt at the top of your browser or a pop up message. Click **Always run on this site** or check the **Do not show me the warning for this program again** box and click **Allow**.

5. Click and choose the file(s) to upload.

6. Fill in the required fields for each file.

- **Title:** A brief description of the spot
- **Brand:** The brand of the spot
- **AD-ID:** A short, unique code to identify the spot
- **Duration:** The length of the spot in seconds

	Filename: TESTH.mov Remove	Status	
	Title	Title of Commercial	Queued
	Brand	Brand of Commercial	
	AD-ID	TESTH <input type="button" value="HD"/> ?	
	Duration	30	

Ad-ID/ISCI Specifications

- Only Alpha-Numeric characters are allowed (A-Z, 0-9)
- ALL upper case
- NO spaces or dashes
- HD Files: Between 2 & 12 characters
- HD Files: Last character MUST BE an H

Quick Reference Guide: Creating a Delivery Order for Altice

7. Click 

7. If this is your first time uploading a spot, you will be prompted to allow Aspera Connect to connect to Yangaroo DMDS. Check **Use my choice for all connections with this host** and click **Allow**.



8. After your uploads complete you will see the message below. If you do not have any more spots to upload, click the  button.

Upload Video

 Your uploads are complete. If you would like to upload more files, click on **Select Files** to start uploading again

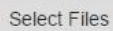



9. You can now continue delivering your spots to Altice with the steps in the section “Creating a Delivery Order”.

Quick Reference Guide: Creating a Delivery Order for Altice

Creating a Delivery Order

Click the **Manage** button and select **Create Order**.

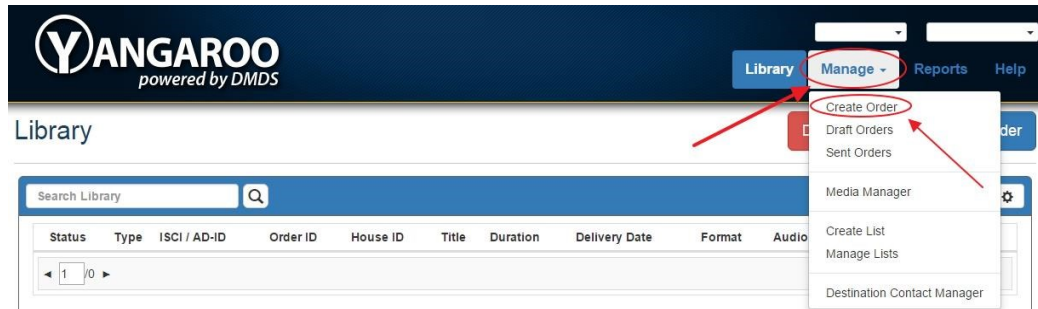

1. In the pop up window, fill in the two required fields and click **Create Order**.
 - **Order Name:** Enter anything that will identify this delivery order to you. Ex.: “Bob’s Autos May 4 2015”.
 - **Brand:** The name of the brand or of the advertiser of the spots being sent. If you are a production house, this is usually the name of your client.
 - **Traffic:** The traffic option is not required but an option if you wish to send traffic along with your commercial. See page 8 for more info on using this feature.

Create Order ×

Order Name

Brand

Traffic

 No Traffic on Order
Send traffic instructions with order.

2. Enter any additional information you want to include in the **Order Details** section and click **Next Section**. Remember, *Order Name*, *Brand*, *Contact Name*, and *Contact Email* are required. Information in any of the other fields will help identify your order.

Quick Reference Guide: Creating a Delivery Order for Altice

3. Click on the **Browse Existing Media** button.

ISCI	Brand	Title	Duration	Format	Commands

4. In the pop up window that opens, you will see the files you previously uploaded. Select the files you would like to add and click **Add Selected**.

ADID/ISCI	Brand	Duration	Format	Captions	Date	State
<input type="checkbox"/> BOBAUTO1234H	Bobs Autos	30	HD		5/4/15 4:27 PM	

5. Click **Next Section** after adding all of your media. You will see three large buttons to pick which Altice *sales* office will receive your spots. If you are unsure which office to send to, please contact your Altice account executive.

Quick Reference Guide: Creating a Delivery Order for Altice

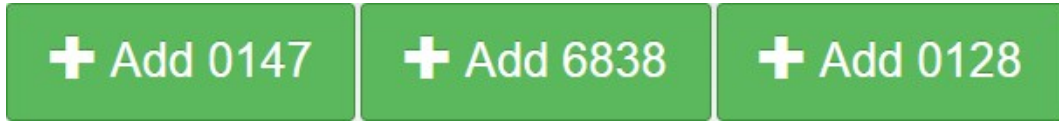

If you do not see these three buttons, please log out and close the browser tab. Open a new tab and navigate to dmds.me/cms.



You can send to more than one destination, even outside of Altice. Type part of a destination name in the left column and DMDS will try to find the right destination or browse the entire YANGAROO footprint. *Note: Additional charges may apply for delivery to non-Altice destinations.*

Destinations Added

Matched Destinations 3 Multiple Matches 0 No Match 0 Show All 1

Destination Name	Matched Destination	Delivery	Formats
Cablevision LI N Nassau-cable(CVLN)-Cablevision Local Sales-6838	Cablevision LI N Nassau-cable(CVLN)-Cablevision Local Sales-6838		
2806	2806 Time Warner Cable TW-All Network Zone, NY		
WABC	WABC-TV		

Select all the destinations that you are sending media to. Type or paste a spreadsheet column in to the grid below. If any of your search terms matches more than one destination, click the 'Click to resolve' boxes and select the correct destination. If any of your search terms, don't match a destination, you can browse the destination list.
Working with many destinations that you will send to repeatedly? Save or load a custom list of destinations to save time.

8. After you select your destination, click

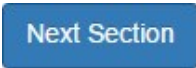

9. Review your order and click



Quick Reference Guide: Creating a Delivery Order for Altice

Adding Traffic to an Order

Optionally, you can send traffic instructions or another document with your spots. It is not required that you send traffic instructions through **DMDS**, if you have another method of sending your instructions. If you need to send traffic without sending media or you need to send more than one document per destination, please contact **YANGAROO Ad Support** to discuss your workflow.



If you wish to send traffic instructions or another document with your spots, you *must* select the option to do so when first naming your order. If you forget to choose to include traffic while naming your order, you will need to create a new order.

Click the button that says **“No Traffic on Order”**. The button will change to **“Send Traffic with Order”**. Once this is done select **“Create Order”**.

1. After selecting your spots and destinations, you will next see the **Traffic** page. Click on the drop down menu that is on the right hand side of the destination and select **“Upload Traffic Document”**. Select your traffic document and it will be listed next to the destination. Repeat this step for each destination.

Quick Reference Guide: Creating a Delivery Order for Altice

Instructions
Upload your traffic document(s) on the right. Choose how to organize your traffic distribution: individual **destinations**, by **market**, or by **group**. Assign documents to destinations, markets, or groups.

Traffic

Sort By: Destination Market All Destinations

▼ All

Norwalk-cablevision (CVFF) - Cablevision Local Sales - 0147	None	
---	------	--

Additional Traffic Notes

These notes will be sent to every destination receiving traffic.

Traffic Search [x]

Filename

Upload Document Clear All Files

2. In the **Additional Traffic Notes** box, you can add in any additional notes. Use this space to include any information that will help identify your spots, like your Account Executive.
3. Click on the Next Section button to continue to the **Delivery Summary** page.

Getting Help

1. **Live Chat:** When a customer service representative is online, chat live with Yangaroo for help with your upload and delivery order
2. **Phone:** Call Yangaroo Ad Support at +1 (866) 992-9902
3. **Email:** Email Yangaroo Ad Support at adsupport@yangaroo.com



Video Specifications

HD Video Requirements:

- Video format: NTSC
- Aspect ratio: 16:9
- Size: 1920x1080 or 1280x720 pixels
- Duration: +/- 3 frames
- Frame rate: 29.97fps
- Minimum bit rate: 6 Mb/sec
- Maximum bit rate: 55 Mb/sec
- Field dominance: Upper (Top)
- Chroma: 4:2:0 or 4:2:2
- Slate: No Slate
- Codecs: Mpeg-TS or H.264 are preferred
- File Extensions: mov, mp4, mpg, or mpeg only

Audio

- Bit rate: 192kpbs
- Sample rate: 48 KHz
- Channels: 2 (Mixed on left and right)
- Tolerance: 2 dB
- Peak analog audio level: 0dBu
- Codecs: Mpeg layer II, PCM, AAC, AC-3